

Media Nonproyeksi dan Proyeksi

Nonproyeksi

- Benda nyata
 - Model
 - Gambar
 - Grafik (graphs)
 - Diagram (charts)
 - Poster
 - Bahan tercetak
 - Buletin
-

Benda nyata

- Benda yang bisa diakses dan punya nilai pendidikan
 - Cocok untuk memperkenalkan konsep baru dan abstrak
 - Misalnya:
 - potongan (untuk mengetahui cara kerja bagian dalam)
 - contoh/sampel
 - barang pameran
-

Model

- Representasi 3D dari benda sesungguhnya
 - Bisa lebih kecil, besar atau sama
 - Bisa detail atau sederhana
-

Gambar

- Foto (orang, tempat, benda), ilustrasi, kartu pos
 - Tersedia dengan mudah dari buku, majalah, koran, katalog, kalender
 - Mudah digunakan
 - Keterbatasan: sering terlalu kecil, dua dimensi
-

Contoh Grafik (Graphs)

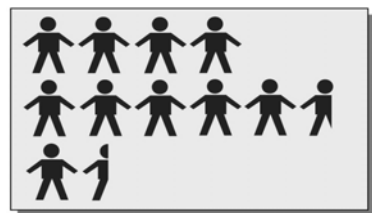
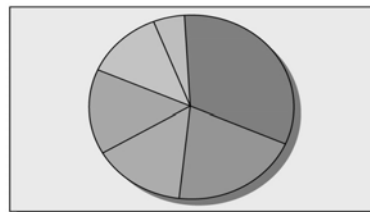
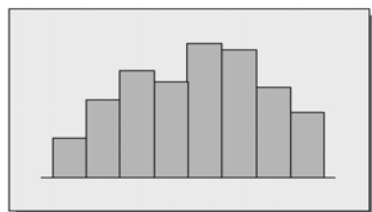

Contoh Diagram (Charts)

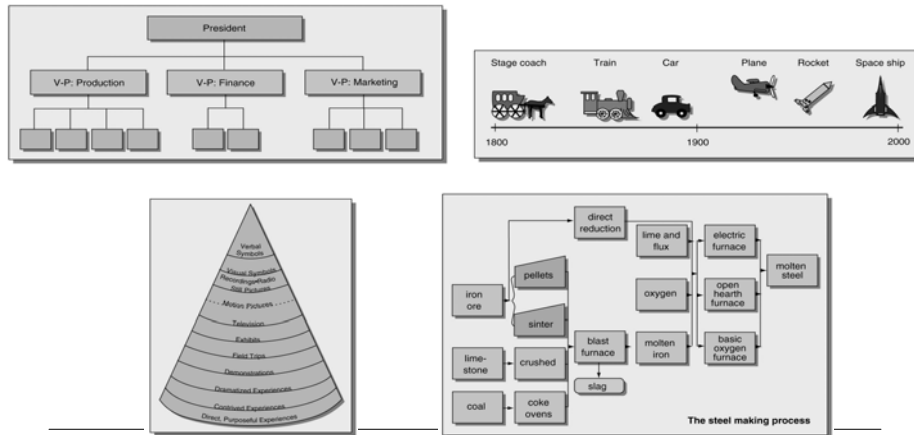

Proyeksi

- Overhead projection (OHP)
 - Slides
 - Filmstrips
 - Opaque projection
-

Contoh OHP

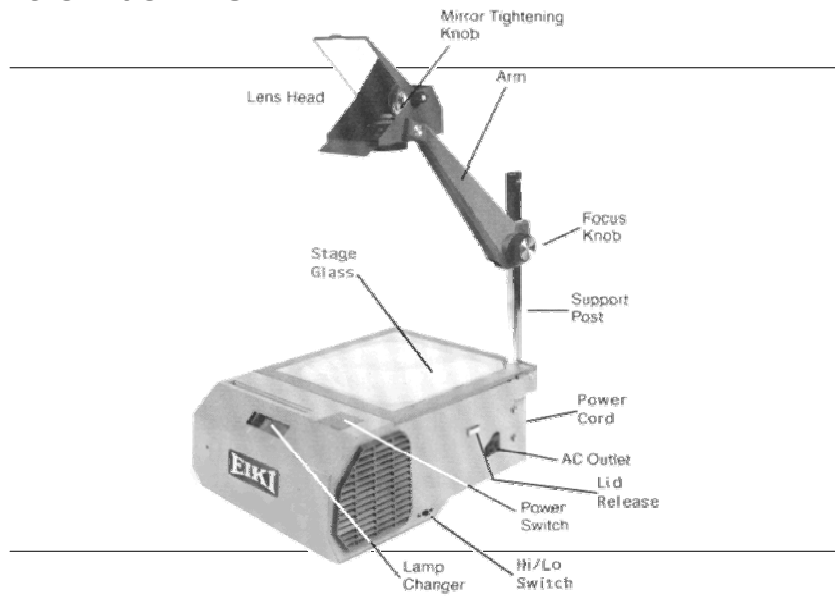

Struktur OHP

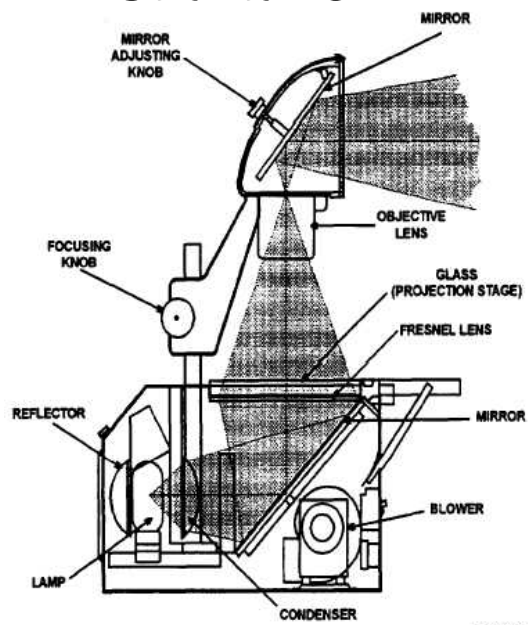

DMNP0115

Keuntungan OHP

- Presenter menghadap audience
 - Mudah pengoperasian
 - ON-OFF untuk fokus perhatian
 - Material mudah dimanipulasi
 - Urutan materi bisa dimodifikasi
 - Ruang tidak perlu gelap
 - Biaya produksi relatif murah
-

Transparansi berlapis

- Base + overlay
 - Overlay elaborates base
 - Enhancements
 - Color
 - Layers
 - Other
 - Frame or sleeve
-

Merancang transparansi

- Format horisontal
 - Ide visual
 - Konsep tunggal
 - Tulisan minimal
 - Keyword/judul
 - Keterbacaan
-

Format Horisontal

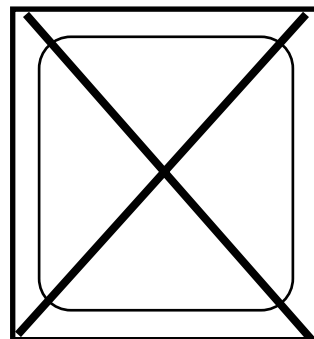
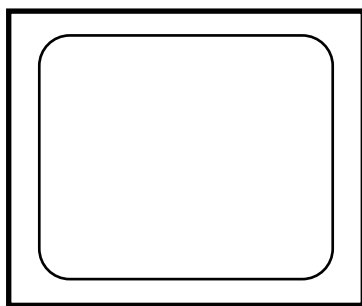

Ide Visual

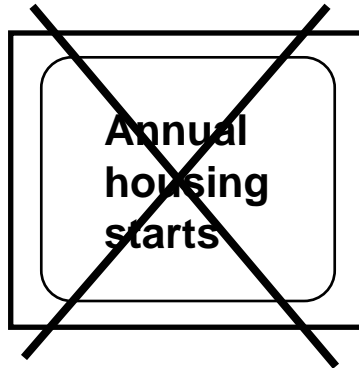
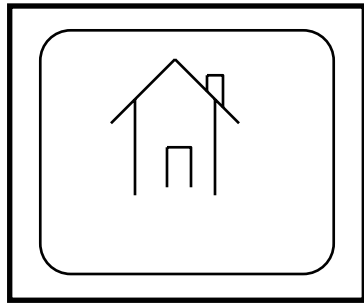

Konsep Tunggal

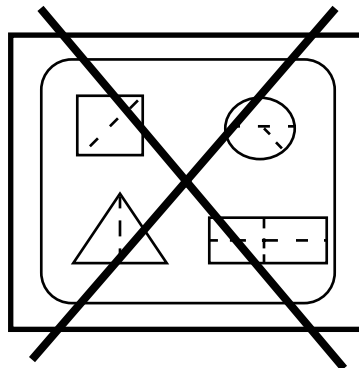
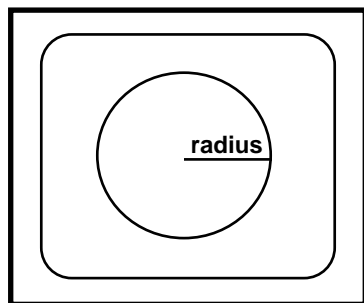

Tulisan minimal

U.N. Cost-of-Living Index 1985	
Rural	Urban
//// //	//// // ////
//// //	//// //
//// // //	//// ////

~~Cost of living of United Nations personnel interrelated cities as connected by index of retail prices, 1985
See next Transp.~~

Key Words / Judul

Mexico Leads Latin America in exports

~~~~~

~~Country Exports~~

~~~~~

~~~~~

## Keterbacaan

---

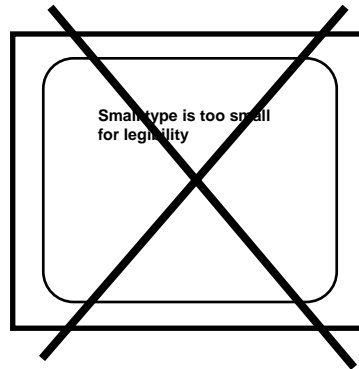
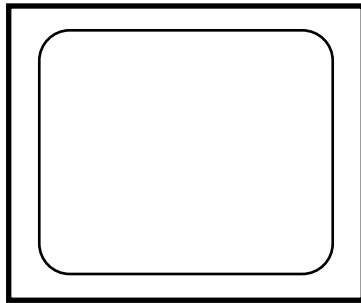

## Mengapa OHP?

---

Outline Formats are Easier  
to Follow

---

## Use Bullets, Not Numbers

---

- Bullets imply no significant order
  - Use numbers only to show rank or sequence
- 

## Isi Transparansi?

---

No More than One Topic  
per Slide

---

Use the 6 X 6 rule:

---

6 lines of text  
6 words per line

Allow plenty of room around  
borders and illustrations

---

## Select Readable Type Size

This is 40 point

---

- Minimum 36 point for titles  
45 point
  - 24 point for body text  
40 point
  - This is 32 point  
35 point  
30 point  
25 point  
20 point  
15 point  
10 point
- 

## Use a Readable Typeface and Font

---

- Use Sans serif (no curly feet) such as Arial or universal for body text
- Use San serif (no curly feet) such as Arial or universal for body text
- Use serif such as a roman for titles only

Use a Readable Typeface and  
Font

---

## Typeface Examples

---

- Typeface Examples
  - Arial
  - Typeface Examples
  - Times New Roman
  - Typeface Examples
  - Courier New
  - Typeface Examples
  - GillSans
- 

## Adjust Lettering to discriminate or emphasize

---

- Make titles a larger type size than body elements
  - emphasize important statements or words with **bold**, *italic*, larger size or **different fonts**.
-

## Choose Color Carefully

---

- Use the same color consistently throughout the presentation
  - Use light letters on a dark background
- 

## Colors

---

- Avoid placing saturated primary colors (red, green or blue) adjacent to each other.
- They may create a third color where the two colors meet.

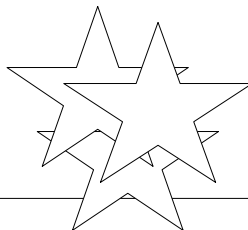

## Use Solid Colors instead of fill Patterns on Charts

---

- Patterns on bars or pie slices cause confusion.
- Solid colors convey a clear bold message

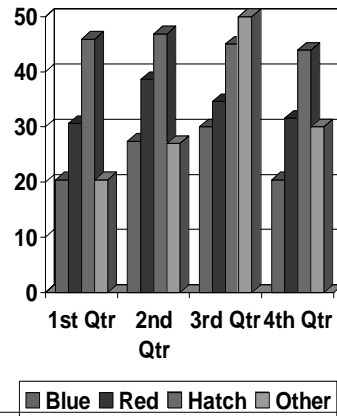

- 
- Use Simple Tables to Present Numbers
  - Add Clipart where appropriate

Try not to make footnotes too small

---



## Tip menggunakan OHP

---

- Presentasikan transparansi sambil menghadap audience
  - Jangan menunjuk ke layar
  - Gunakan alat bantu untuk menunjuk
  - Gunakan ON-OFF untuk memfokuskan perhatian
  - Buka tahap demi tahap
  - Bila memerlukan catatan, gunakan frame
-